



深圳市希恩凯电子有限公司

SHENZHEN CNK ELECTRONIC CO.,LTD.

Product Specification For LCD Module

Model NO. : CNKD0301-11001A

REVISION : A

APPROVAL FOR SPECIFICATIONS ONLY

APPROVAL FOR SPECIFICATIONS AND SAMPLE

CUSTOMER :

APPROVED BY :

CNK LCM R&D CENTER

APPROVED BY

CHECKED BY

PREPARED BY

DIRECTOR

MANAGER

Engineer

深圳市希恩凯电子有限公司

SHEN ZHEN CNK ELECTRONICS CO.,LTD

深圳市宝安区沙井南环路鸿桥工业园 2 期 B 栋 4 楼

TEL : 0755-28024001,29761676

FAX : 0755-28021718

<http://www.szcnk.com>

 深圳市希恩凯电子有限公司 SHENZHEN CNK ELECTRONIC CO.,LTD.	MODEL NO.		PAGE
	CNKD0301-11001A	SPEC SAMPLE	2

2. TABLE OF CONTENTS

NO	CONTENTS	PAGE
1	COVER	1
2	TABLE OF CONTENTS	2
3	RECORD OF REVISION	3
4	GENERAL SPECIFICATION	4
5	LCD ELECTRO-OPTICAL CHARACTERISTICS	5
6	LCD OPTICAL CHARACTERISTICS	5
7	OPTICAL CHARACTERISTICS DEFINITION	6
8	INTERFACE PIN ASSIGNMENT	7
9	BACKLIGHT	8
10	BLOCK DIAGRAM	9
11	RELIABILITY	10
12	INSPECTION CRITERIA	11-12
13	PRECAUTION FOR USE OF LCD MODULE	13-14
14	LCM DRAWING	15-16

 深圳市希恩凯电子有限公司 SHENZHEN CNK ELECTRONIC CO.,LTD.	MODEL NO.		PAGE
	CNKD0301-11001A	SPEC SAMPLE	4

4. GENERAL SPECIFICATION

ITEM	CONTENTS
Module Size	66(W) × 32(H) × 9.5 (T) mm
Display View Area	40(W) × 20(H) mm
LCD Type	FSTN /NEGATIVE/TRANSMISSIVE
View Angle	12 O'clock
Backlight Driver type	Power /BLUE
Driver IC	HT1621
DC to DC circuit	Build-In
Weight	TBD

5. LCD ELECTRO-OPTICAL CHARACTERISTICS (Ta=25°C)

Item	Symbol	Condition	Min.	Typ.	Max.	Unit
LCD Module Driving Voltage	VOP	Ta=25°C	3.5	4.0	4.5	Volt
Operating Temperature	Top	--	0°C	-	+50°C	°C
Storage Temperature	Tst	--	-10°C	-	+60°C	°C
Humidity	%	--	--	90%		

Note: See section 12 for backlight uniformity measurement

6. LCD OPTICAL CHARACTERISTICS

Item	Symbol	Temp(°C)	Rating			Unit	Reference
			Min	Typ	Max		
Recommended Driving Voltage	Vop	50				V	
		25	3.5	4.0	4.5		
		0					
Response Time	Rise Time	Tr	25	180	230	ms	Note4
	Fall Time	Tf	25	180	230		
Frame Frequency	FR	25	70	75	80	Hz	
Viewing angle Cr≥2	∅=0°	θ ₁	25	25		Deg	Note1 Note2
	∅=180°	θ ₂		25			
	∅=90°	θ ₃		15			
	∅=270°	θ ₄		35			
Viewing Direction		12 O'clock					
Contrast Ratio	Cr	25	6	8			Note3

7. OPTICAL CHARACTERISTICS DEFINITION

Note 1. Definition of angle θ_1 & θ_2

Note 2. Definition of angle θ_3 & θ_4

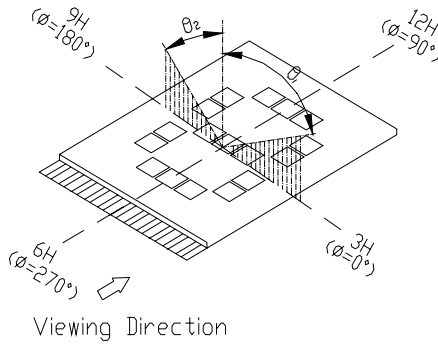
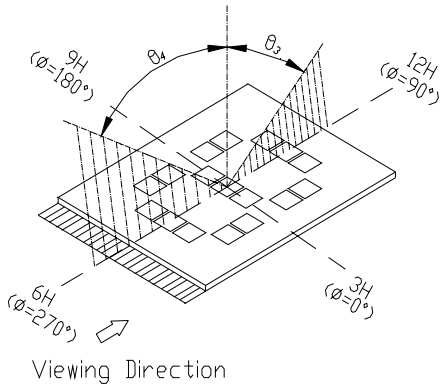

LCD Panel

Note 3. Definition of contrast ratio (Cr2)

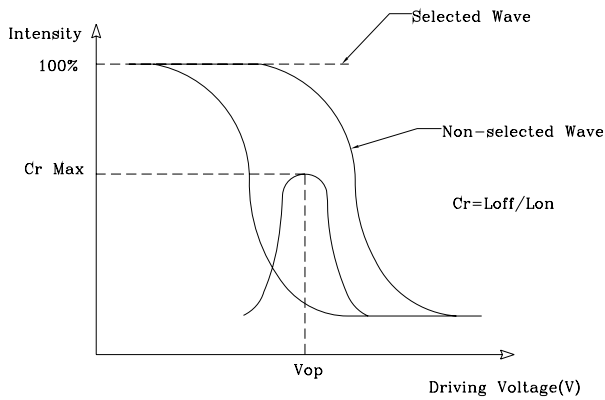

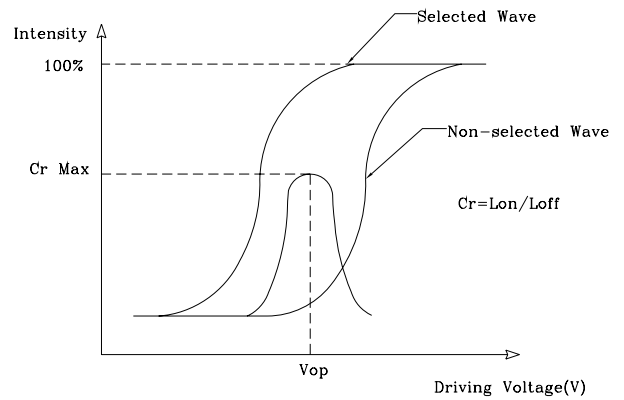

[Positive type]

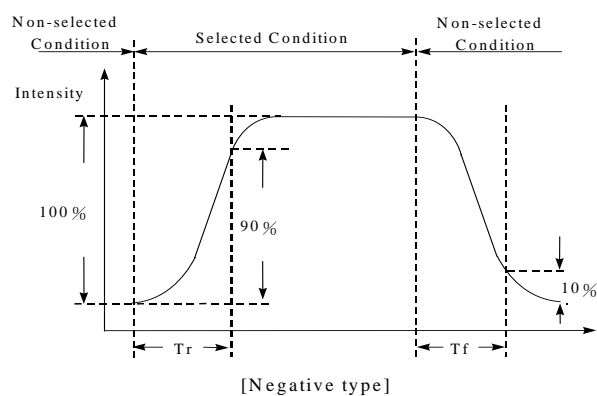
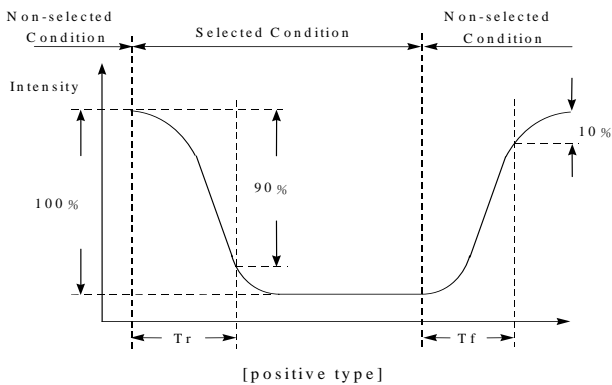

[Negative type]

Note 4. Definition of response time



 深圳市希恩凯电子有限公司 SHENZHEN CNK ELECTRONIC CO.,LTD.	MODEL NO.		PAGE
	CNKD0301-11001A	SPEC SAMPLE	7

8. INTERFACE PIN ASSIGNMENT

PIN	SYMBOL	FUNCTIONS
1	VSS	power GND
2	VDD	Power supply for logic
3	DATA	Data bus line
4	/RD	Read enable clock input pin,the data on D0 to D7 are latched at the falling edge of the /WR signal
5	/CS	When /CS="L",then the chip select becomes active
6	/WR	Read/write selection(H:Read,L:Write)
7	NC	-----
8	BL	Power supply for LED backlight
9	NC	-----
10	NC	-----
11	NC	-----
12	NC	-----

9. BACKLIGHT

BACKLIGHT ELECTRICAL-OPTICAL CHARACTERISTICS (Unless specified, Ambient temperature $T_a=25^{\circ}\text{C}$)

PARAMETER	Sym.	Min.	Typ.	Max.	Unit	Test Condition	Reference
Supply Current	I	--	30	40	mA	30mA	
WHITE LED	V	2.9	3.1	3.3	V	30mA	--
Backlight Luminous Intensity	Lv	--	--	--	Cd/m ²	30mA	Note1
Uniformity	--	70	--	--	%	30mA	Note1 Note2

NOTE:

1. Backlight luminance: The measurement instrument is BM-7 luminance colorimeter. The aperture of colorimeter is $\varnothing 5\text{mm}$ and the distance between lens and backlight is 50cm. 5 points will be measured and the luminance of backlight is the average value of 5 points.

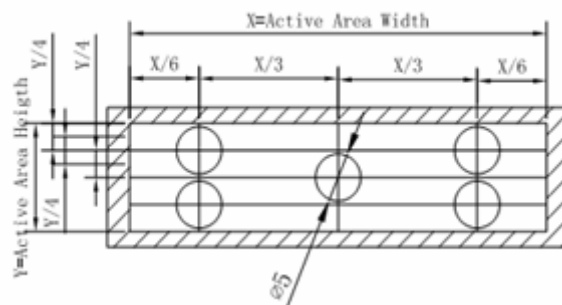

measure point on backlight

2. Backlight Uniformity = $(\text{The Luminance min} / \text{The Luminance max}) \times 100\%$

10.BLOCK DIAGRAM

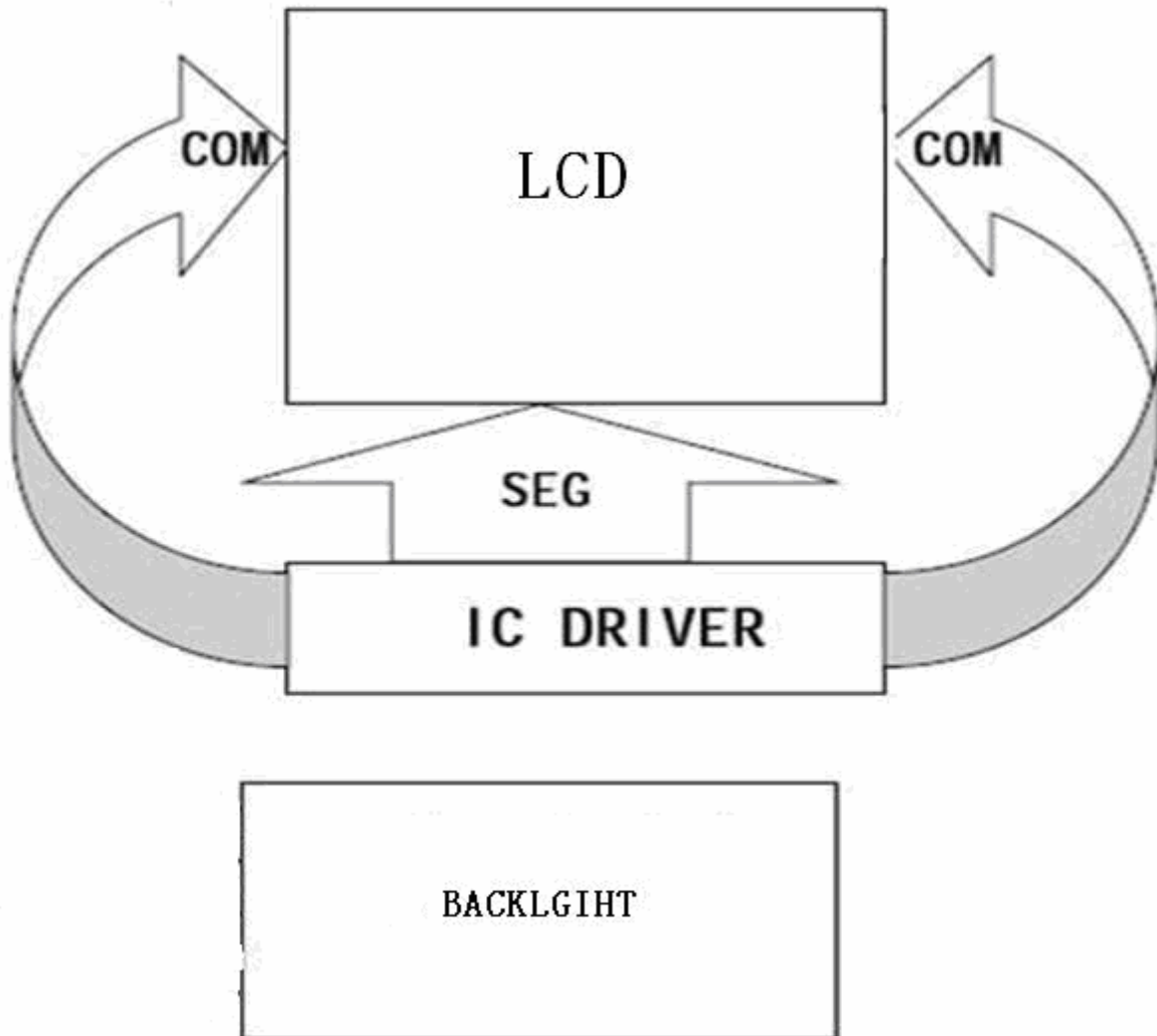

A.C. Characteristics

Command mode (command code : 1 0 0)

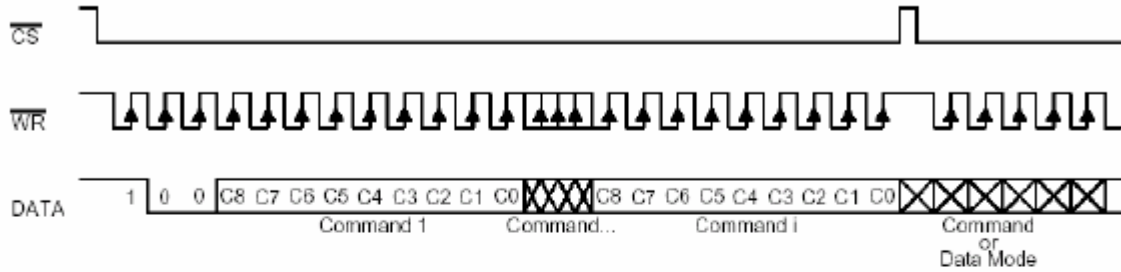

Mode (data & command mode)

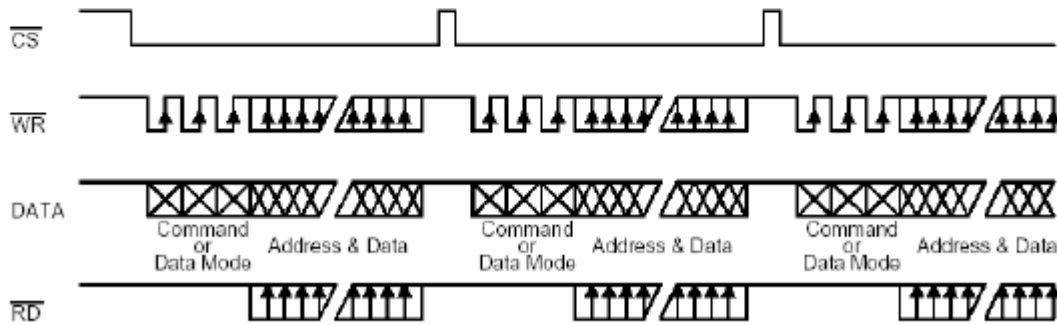

WRITE mode (command code : 1 0 1)

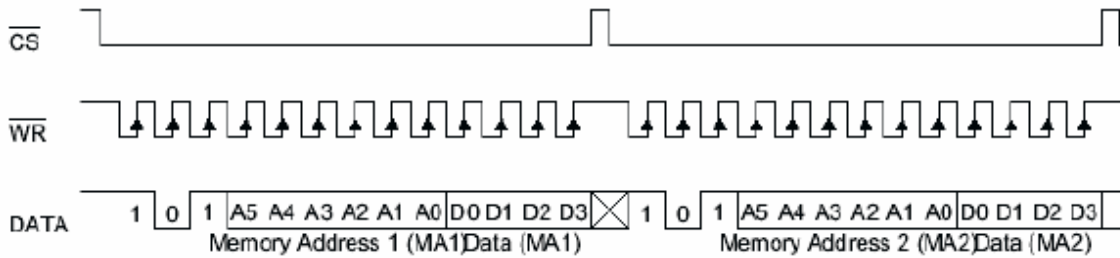

WRITE mode (successive address writing)

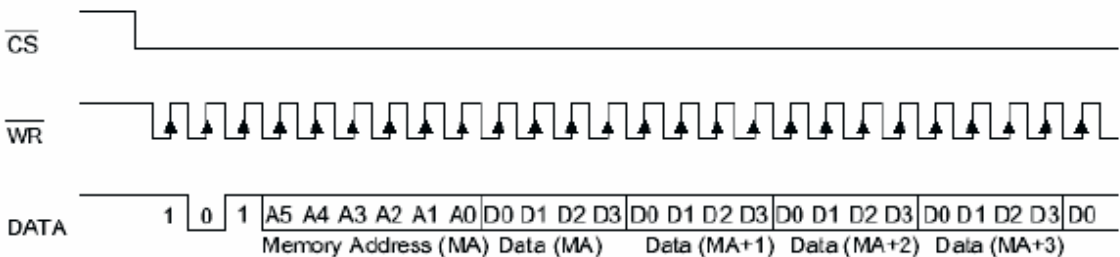

12. RELIABILITY

	No	Test Item	Content of Test	Test Condition
Environment Test	1	High Temperature Storage	Endurance test of high temperature for a long time.	80℃ 96H
	2	Low Temperature Storage	Endurance test of low temperature for a long time.	-20±2℃ 96H
	3	High Temperature Operation	Endurance test of electrical stress (Voltage & Current) and the thermal stress to the element.	70℃ 96H
	4	High Temperature /Humidity Storage	Endurance Test of high temperature and high humidity for a long time.	45±2℃ 90±2%RH 96H
	5	Thermal shock	Endurance test of low and high temperature cycles.(air to air) $-20\pm 2^{\circ}\text{C} \longleftrightarrow 70\pm 2^{\circ}\text{C}$ $(60\text{min}) \longleftrightarrow (60\text{min})$ 1 cycle	-10±2℃/70±2℃ 10 cycle
	6	vibration	Maximum vibration is 2.45m/s ² (0.25 G) during operation and 11.75 m/s ² (1.2 G) during storage. Tested 10-100KHz XYZ directions 1 hour each.	Ambient temperature Ta=25℃
	7	shock	Maximum shock is 29.4 m/s ² (3 G) during operation and 490.0 m/s ² (50 G) during storage. Tested 10 milliseconds in XYZ directions 1 time each.	Ambient temperature Ta=25℃

Note:

- 1) Condensation is not allowed during low temperature testing.
- 2) Driving condition for operation test:

Power Supply Current for BackLight(I_{mA})=15mA

Failure Judgment Criterion

After the above mentioned test (For Environmental Test, after 2 hours in room temperature):

- 1) There should not be conspicuous failure of display quality and appearance.
- 2) Contrast ratio should be greater than or equal to 50% of the initial contrast ratio.
- 3) Abnormal function is a failure.

13. INSPECTION CRITERIA

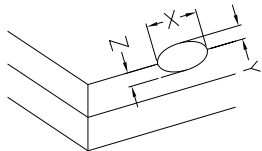
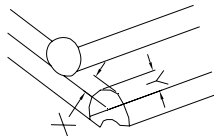
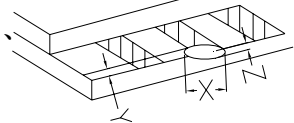
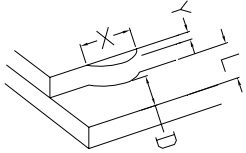
NO	Item	Criteria	AQL																		
1	Electrical Testing	(1) non-display (2) segment missing (3) segment short	0.65																		
2	Dimension state	Dimension out of the specification	1.00																		
3	Glass crack	<p>Substrate check symbol Definition: X: Length direction Y: Short side direction Z: Thickness direction T: Glass thickness K:LCD length L: Single connector width</p> <p>(1) General crack</p>  <table border="1" data-bbox="813 999 1347 1164"> <tr> <th>X</th> <th>Y</th> <th>Z</th> </tr> <tr> <td>$1/8K \geq$</td> <td>Not over viewing area</td> <td>$T \geq$</td> </tr> </table> <p>(2) Corner</p>  <table border="1" data-bbox="813 1214 1347 1379"> <tr> <th>X</th> <th>Y</th> <th>Z</th> </tr> <tr> <td>$1/8K \geq$</td> <td>Not over viewing area</td> <td>No check</td> </tr> </table> <p>(3) Contact pad crack</p>  <table border="1" data-bbox="900 1496 1353 1662"> <tr> <th>X</th> <th>Y</th> <th>Z</th> </tr> <tr> <td>$1/8K \geq$</td> <td>$1/3L \geq$</td> <td>No check</td> </tr> </table> <p>1. Cracks on the contact area cannot exceed 1/2 of the glass thickness. 2. Y not to exceed 1/3 seal width</p> <p>(4) Substrate protuberance and internal crack</p>  <p style="text-align: right;">$D < 2/3L$,Reject</p> <p>(5) No progressive glass cracks allowed</p>	X	Y	Z	$1/8K \geq$	Not over viewing area	$T \geq$	X	Y	Z	$1/8K \geq$	Not over viewing area	No check	X	Y	Z	$1/8K \geq$	$1/3L \geq$	No check	2.50
X	Y	Z																			
$1/8K \geq$	Not over viewing area	$T \geq$																			
X	Y	Z																			
$1/8K \geq$	Not over viewing area	No check																			
X	Y	Z																			
$1/8K \geq$	$1/3L \geq$	No check																			

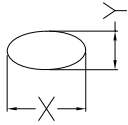
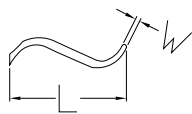
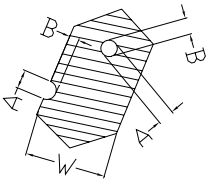
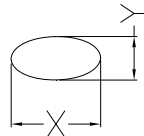
NO	Item	Criterion	AQL																								
4.	Black spot , white spot (including polarizer) $\varnothing = (X+Y) / 2$ unit:mm	(1) Round type  <table border="1"> <thead> <tr> <th>Size</th> <th>Acceptable QTY</th> </tr> </thead> <tbody> <tr> <td>$\varnothing \leq 0.10$</td> <td>Accept</td> </tr> <tr> <td>$0.10 < \varnothing \leq 0.20$</td> <td>2</td> </tr> <tr> <td>$0.20 < \varnothing \leq 0.25$</td> <td>1</td> </tr> <tr> <td>$0.25 < \varnothing$</td> <td>0</td> </tr> </tbody> </table> (2) Line type  <table border="1"> <thead> <tr> <th>Length L</th> <th>Width W</th> <th>Acceptable QTY</th> </tr> </thead> <tbody> <tr> <td>accept</td> <td>$0.015 \geq W$</td> <td>No check</td> </tr> <tr> <td>$3.0 \geq L$</td> <td>$0.050 \geq W$</td> <td rowspan="2">2</td> </tr> <tr> <td>$2.5 \geq L$</td> <td>$0.080 \geq W$</td> </tr> <tr> <td></td> <td>$0.100 < W$</td> <td>As round type</td> </tr> </tbody> </table> (3) No more than 2 spots and lines within 3 mm. Maximum combined total of round and line defects is 4. (4) Scratches criterion is same as that of Round type.	Size	Acceptable QTY	$\varnothing \leq 0.10$	Accept	$0.10 < \varnothing \leq 0.20$	2	$0.20 < \varnothing \leq 0.25$	1	$0.25 < \varnothing$	0	Length L	Width W	Acceptable QTY	accept	$0.015 \geq W$	No check	$3.0 \geq L$	$0.050 \geq W$	2	$2.5 \geq L$	$0.080 \geq W$		$0.100 < W$	As round type	1.50
Size	Acceptable QTY																										
$\varnothing \leq 0.10$	Accept																										
$0.10 < \varnothing \leq 0.20$	2																										
$0.20 < \varnothing \leq 0.25$	1																										
$0.25 < \varnothing$	0																										
Length L	Width W	Acceptable QTY																									
accept	$0.015 \geq W$	No check																									
$3.0 \geq L$	$0.050 \geq W$	2																									
$2.5 \geq L$	$0.080 \geq W$																										
	$0.100 < W$	As round type																									
5.	Pixel deformation	Symbols: W: segment width \varnothing : average of diameter $= (A+B) / 2$ (1) Pin hole and deformation  <table border="1"> <thead> <tr> <th>Width</th> <th>Acceptable Defect</th> </tr> </thead> <tbody> <tr> <td>$W < 0.4$</td> <td>$\varnothing \leq 0.20$ and $\varnothing \leq 1/2W$</td> </tr> <tr> <td>$W \geq 0.4$</td> <td>$\varnothing \leq 0.25$ and $\varnothing \leq 1/3W$</td> </tr> </tbody> </table> <p>\varnothing under 0.10mm ,acceptable</p> (2) Pixel size should be in the range of 95% to 100% of the normal dimension and the gap between pixels should be less than 150% of normal dimension.	Width	Acceptable Defect	$W < 0.4$	$\varnothing \leq 0.20$ and $\varnothing \leq 1/2W$	$W \geq 0.4$	$\varnothing \leq 0.25$ and $\varnothing \leq 1/3W$	2.5																		
Width	Acceptable Defect																										
$W < 0.4$	$\varnothing \leq 0.20$ and $\varnothing \leq 1/2W$																										
$W \geq 0.4$	$\varnothing \leq 0.25$ and $\varnothing \leq 1/3W$																										
6.	Polarizer bubble $\varnothing = (X+Y) / 2$	 <table border="1"> <thead> <tr> <th>size \varnothing</th> <th>Acceptable QTY</th> </tr> </thead> <tbody> <tr> <td>$\varnothing \leq 0.20$</td> <td>No check</td> </tr> <tr> <td>$0.20 < \varnothing \leq 0.50$</td> <td>3</td> </tr> <tr> <td>$0.50 < \varnothing \leq 1.00$</td> <td>2</td> </tr> <tr> <td>$1.00 < \varnothing$</td> <td>0</td> </tr> <tr> <td>Total QTY</td> <td>3</td> </tr> </tbody> </table>	size \varnothing	Acceptable QTY	$\varnothing \leq 0.20$	No check	$0.20 < \varnothing \leq 0.50$	3	$0.50 < \varnothing \leq 1.00$	2	$1.00 < \varnothing$	0	Total QTY	3	1.5												
size \varnothing	Acceptable QTY																										
$\varnothing \leq 0.20$	No check																										
$0.20 < \varnothing \leq 0.50$	3																										
$0.50 < \varnothing \leq 1.00$	2																										
$1.00 < \varnothing$	0																										
Total QTY	3																										
7.	Contrast	Under normal power supply, uneven contrast is unacceptable.	2.5																								
8.	Rainbow	Obvious uneven color in LCD viewing area is not allowed.	2.5																								

 深圳市希恩凯电子有限公司 SHENZHEN CNK ELECTRONIC CO.,LTD.	MODEL NO.		PAGE
	CNKD0301-11001A	SPEC SAMPLE	1 4

14. PRECAUTION FOR USE OF LCD MODULE

1. Handling Precautions

- 1) The display panel is made of glass. Do not subject it to a mechanical shock by dropping it from a high place, etc.
- 2) If the display panel is damaged, the liquid crystal substance leaks out ,do not ingest. If the substance contacts skin or clothes, promptly wash off using soap and water.
- 3) Do not apply excessive force to the display surface or adjoining areas since this may affect the LCD color
- 4) The polarizer covering the display surface of the LCD module is soft and easily scratched. Handle this polarizer carefully.
- 5) If the display surface is contaminated, breathe on the surface and gently wipe it with a soft dry cloth. If still not completely clear, moisten cloth with one of the following solvents:
 - Isopropyl alcohol
 - Ethyl alcohol
 Solvents other than those mentioned above may damage the polarizer.
 Especially, do not use the following:
 - Water
 - Ketone
 - Aromatic solvents
- 6) Do not attempt to disassemble or process the LCD module.

2. Assembling Precautions

- 1) When mounting the LCD module make sure that it is free of twisting, warping, and distortion. Distortion has great influence upon display quality. Also, use an adequately stiff outer case.
- 2) Please handle the LCD module by its side.
- 3) NC terminal should be open. Do not connect anything.
- 4) If the logic circuit power is OFF, do not apply the input signals.
- 5) To prevent destruction of the elements by static electricity, be careful to maintain an optimum work environment.
 - Be sure to ground the body when handling the LCD module.
 - Tools required for assembly, such as soldering irons, must be properly grounded.
 - To reduce the amount of static electricity generated, do not conduct assembly and other work under dry conditions.
 - The LCD module is coated with a film to protect the display surface. Exercise care when peeling off this protective film since static electricity may be generated.
- 6) Be careful handling the glass panel because it has a very sharp edge.

 深圳市希恩凯电子有限公司 SHENZHEN CNK ELECTRONIC CO.,LTD.	MODEL NO.		PAGE
	CNKD0301-11001A	SPEC SAMPLE	1 5

3. Storage Precautions

- 1) When storing the LCD module, avoid exposure to direct sunlight, to the light of fluorescent lamps, to high temperature or to high humidity. Whenever possible, LCD modules should be stored in the same packaging they were shipped in.
- 2) Exercise care to minimize corrosion of the electrodes. Corrosion of the electrodes is accelerated by water droplets or by current flow in a high-humidity environment.

4. Design Precautions

- 1) The absolute maximum ratings represent the rated value beyond which LCD module can not exceed. When the LCD modules are used in excess of this rated value, their operation characteristics may be adversely affected.
- 2) To prevent the occurrence of erroneous operation caused by noise, attention must be paid to satisfy V_{IL} , V_{IH} specification values including taking the precaution of using signal cables that are short.
- 3) The LCD exhibits temperature dependency characteristics. Since recognition of the display becomes difficult when the LCD is used outside its designated operating temperature range, be sure to use the LCD within this range. Also keep in mind that the LCD driving voltage levels necessary for clear displays will vary according to temperature.
- 4) We recommended that power supply lines (VDD) have over-current protection line. (Fuse etc. Recommend Value:0.5A)
- 5) Sufficiently reduce electrical noise from peripheral devices.
- 6) To cope with EMI, take measures basically on outputting side.
- 7) Assemble LCD module tightly with the application case or PCB.

5. Other considerations

- 1) Liquid crystal solidifies under low temperature (below the storage temperature range) leading to defective orientation or the generation of air bubbles (black or white). Air bubbles may also be generated if the LCD module is subjected to a strong shock at a low temperature.
- 2) If the LCD modules have been operating for a long time showing the same display patterns, the display patterns may remain on the screen as ghost images and a slight contrast irregularity may also appear. A normal operating status can be regained by suspending use for some time. It should be noted that this phenomenon does not adversely affect performance reliability.
- 3) To minimize the performance degradation of the LCD module's resulting from destruction caused by static electricity, etc., exercise care to avoid touching the LCD's electrical connections.
- 4) LCD voltage adjustment may be necessary to obtain the best contrast on each LCD.
- 5) Precaution for disposal of LCD module. When disposal of LCD module, ask specialization company of industrial waste which is permitted by the government. When burn up LCD module, obey the law of environmental hygienic.

15.LCM DRAWING

